

ANYO-45-...

FUEL-OIL BURNER

200-450 kW

Flexible turndown range
High combustion efficiency
Reliable construction
Easy and simple to maintenance
Environmentally friendly

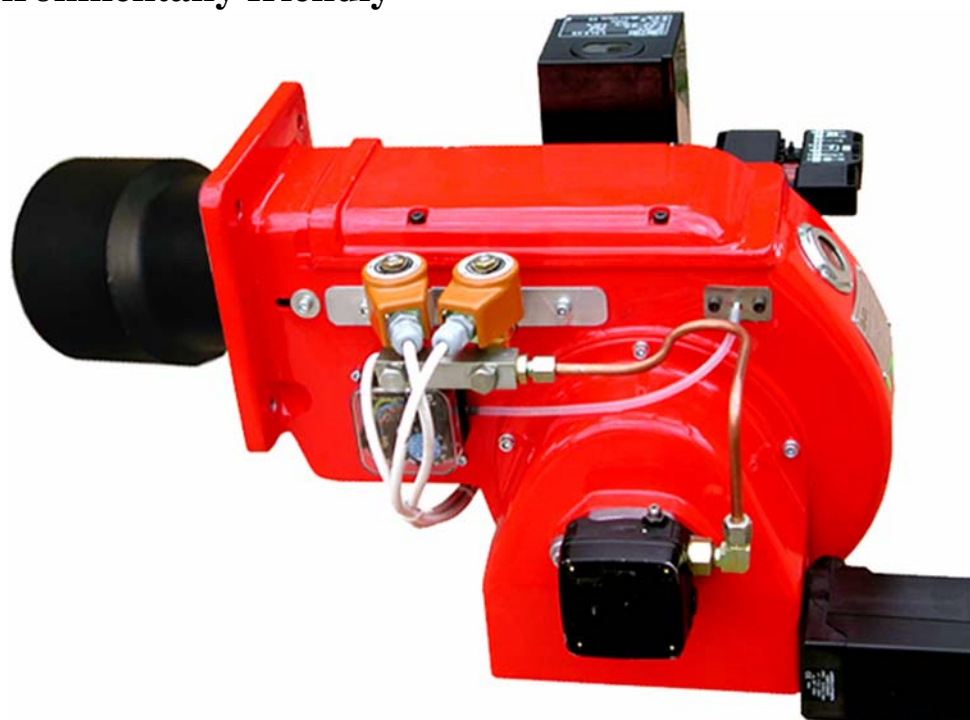

GB-GANZ

Tüzeléstechnikai Kft.
HUNGARY

H-1103 Budapest, Szlávy u. 22-30. Tel.: +36-1-260-2727 F: +36-1- 260-0033

Internet: www.gb-ganz.hu E-mail: gbganz@gb-ganz.hu

General information:

Having developed the ANYO type oil burner series we should like to provide simple, reliable, economic and modern firing devices for the users. The burner is monoblock system, fan assisted, pressure pulverization type, with fully automatically operation, for combustion of light-, and semi-heavy fuel-oil. Its simple construction makes quick fitting and set-up possible, the use of excellent-quality safety-, and control devices results in low maintenance cost. Mode of output control: HIGH/LOW with fast load change. At combustion of semi-heavy fuel-oil the fuel is preheated. Depending on the fuel-oil viscosity the temperatures of the burner starting and pulverization are adjustable by thermostats incorporated. In manufacturing we highly take the users' requirements into consideration, so that, beside the mass-produced burners there is a possibility of delivering also special versions. Standard or extended air-tube equipped burners are well adaptable to any boiler furnace chamber. Ordering burner, kind of fuel-oil has to be taken into consideration. Commissioning relevant legislations and standards have to be observed. The burner can be mounted on industrial, agricultural and communal heating appliances, in case of the burner's characteristic suits the furnace chamber pressure and the requested output.

Advantages:

- high combustion efficiency
- flexible turndown range
- stable flame
- simple and fast electric connection with multi-poled connectors
- simple assemblage, quick maintenance
- wide range of optional accessories
- environment safe, low pollutant emission
- reliable construction
- long-life operation

Fuel-oil supply system schemes:

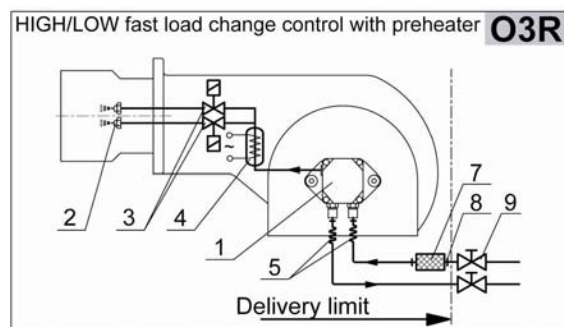
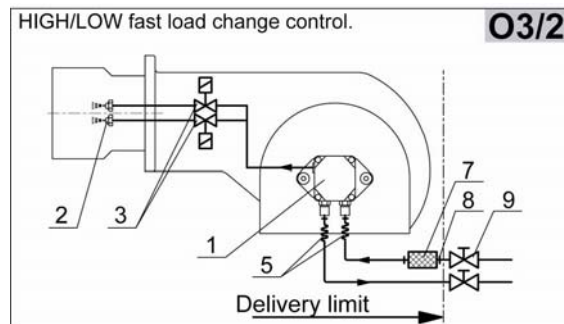
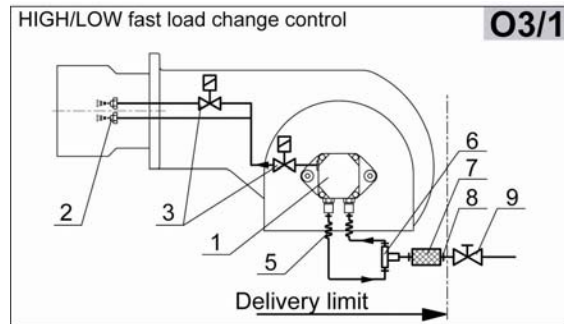

Attachments:

- 1 Fuel-oil pump
- 2 Jet
- 3 Solenoid valve
- 4 Fuel-oil preheater
- 5 Flexible hosing
- 6 Tee-piece
- 7 Oil filter
- 8 Fitting

Optionals for special request

- 9 Manual globe-cock

GB-GANZ

Tüzeléstechnikai Kft.
HUNGARY

H-1103 Budapest, Szilávy u. 22-30. Tel.: +36-1-260-2727 F: +36-1-260-0033

Internet: www.gb-ganz.hu E-mail: gbganz@gb-ganz.hu

Main technical data:

Type	ANYO-45-D	ANYO-45-E	ANYO-45	ANYO-45/R
Output range	140-330 kW	160-380 kW	200-450 kW	200-450 kW
Fuel	Light fuel oil			SHFO*
Mode of output control	HIGH/LOW with fast load change			
Turndown ratio	1:2			
Primary burner control	Landis LOA-26		Landis LAL-2	
Flame detector	Landis QRB 1		Landis QRB 3	
Ignition	Automatically, by high voltage spark			
Electrical connection	230 V, 50 Hz+PE			3x400/230V, 50Hz+PE
El power consumption	300 W	300 W	500 W	4500 W
Electrical protection	IP 40			
Noise level	70-73 dB			

*SHFO: semi-heavy fuel-oil, viscosity at 20 C° 60 cSt (5E°)

Outline drawing and connecting dimensions:

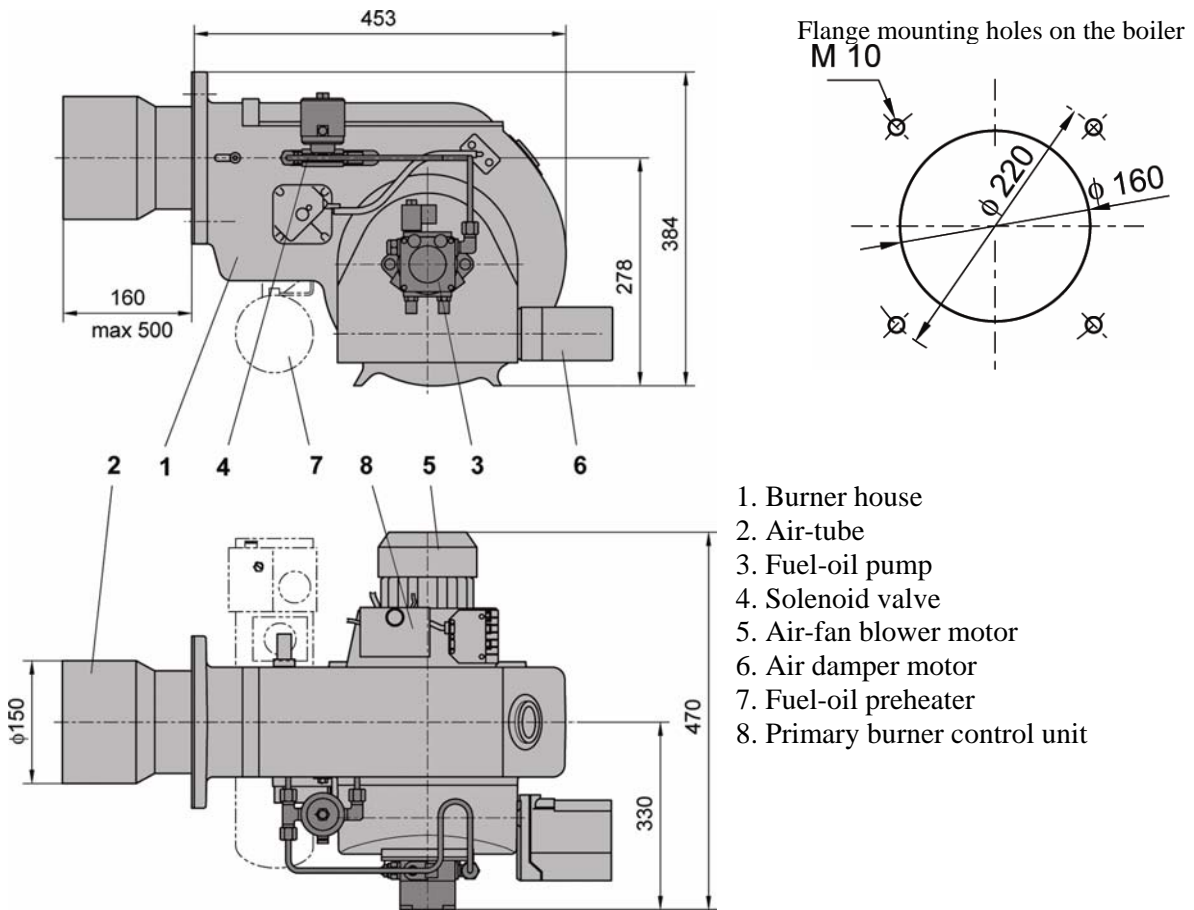

GB-GANZ

Tüzeléstechnikai Kft.
HUNGARY

H-1103 Budapest, Szilávy u. 22-30. Tel.: +36-1-260-2727 F: +36-1-260-0033

Internet: www.gb-ganz.hu E-mail: gbganz@gb-ganz.hu

Funace chamber pressure – burner output characteristics:

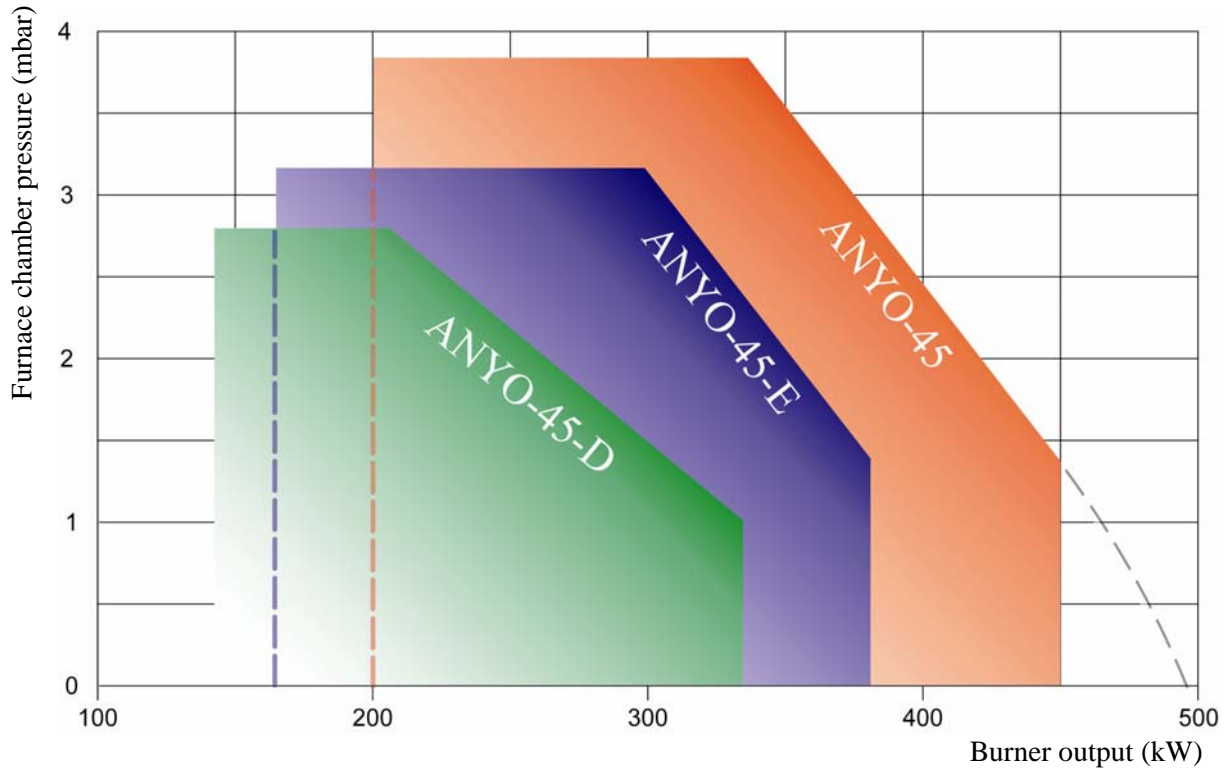

Oil burner type symbols

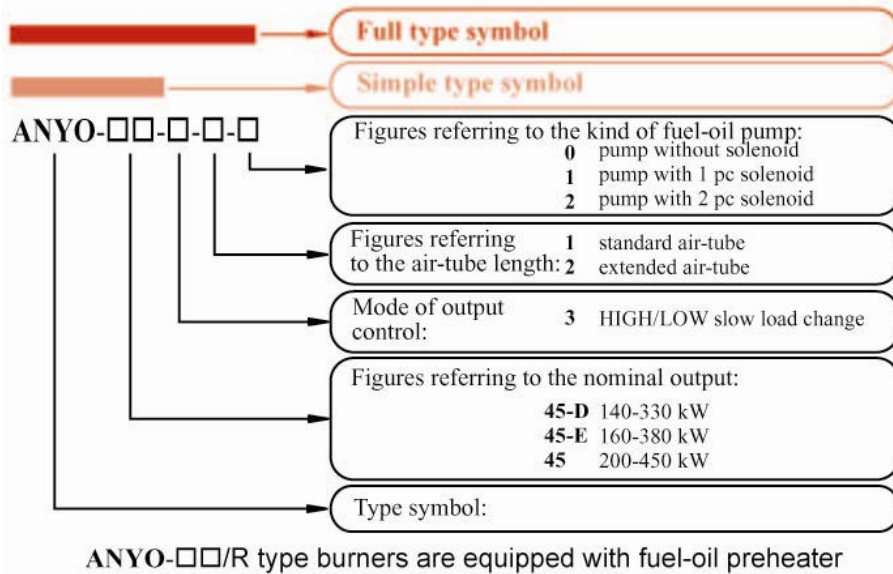

Regional Sales Office:

Transdanubian Sales Office: H-8300 Tapolca Juhász Gy. u. 2/1, Hungary Tel/F.: + 36-87-510-670
 Your regional dealer:



GB-GANZ

Tüzeléstechnikai Kft.
 HUNGARY

H-1103 Budapest, Szilávy u. 22-30. Tel.: +36-1-260-2727 F: +36-1-260-0033

Internet: www.gb-ganz.hu E-mail: gbganz@gb-ganz.hu